

# Pocket Speak & Read

---

MODEL: PVCO, PVCO-C

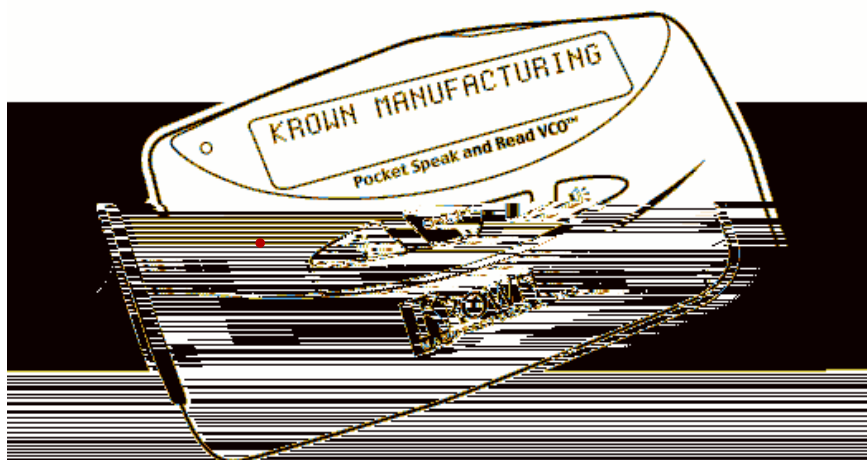

## INSTRUCTIONS

4th Edition

---



## TABLE OF CONTENTS

i: Table of Contents . . . . .	1
ii: Introduction . . . . .	2
I: Installing Battery. . . . .	4
II: Operations . . . . .	5
III: Maintenance . . . . .	9
FAQ	
IV: Specifications . . . . .	11
V:	

The Pocket Speak and Read VCO® (Voice Carry Over) is an innovative product specially designed for the Deaf and Hard of Hearing who can use speech to communicate with others. The PVCO allows you to make a phone call independently without the assistance of another person. you can make a phone call anywhere, anytime, by using any phone with the assistance of your state Relay service. You will find the Relay number of every state in American at the end of this manual.

The PVCO is the smallest and easiest product that allows you to speak directly to the caller using your own voice with no typing. You can make a phone call at home with a landline phone, or enjoy the freedom of using a cordless phone. You will be free from sitting by the phone through a long conversation. Put the PVCO close to a speakerphone and it will give you the opportunity to enjoy handsfree conversation when you are working on the other projects at home or office. Another benefit of the PVCO is you have the ability to take the PVCO with you when you travel. You can call home while on the road by using either the pay phone or the cellular phone. In an emergency, the PVCO will allow you to use the call boxes located on the most major interstate highways to connect with the 911 operator to make your call for assistance\*. At the airport, in the hotel, on the airplane, you always can speak directly to the person you are calling without a barrier and read the message back form the Relay operator or the person with a TTY.

The PVCO is lightweight, thin, pocket sized and also comes with a carrying case and a belt loop attachment making it easier to carry and use wherever you go.



\* Krown Manufacturing, makes no representation that the 911 operator will properly respond to a TTY/TDD call.

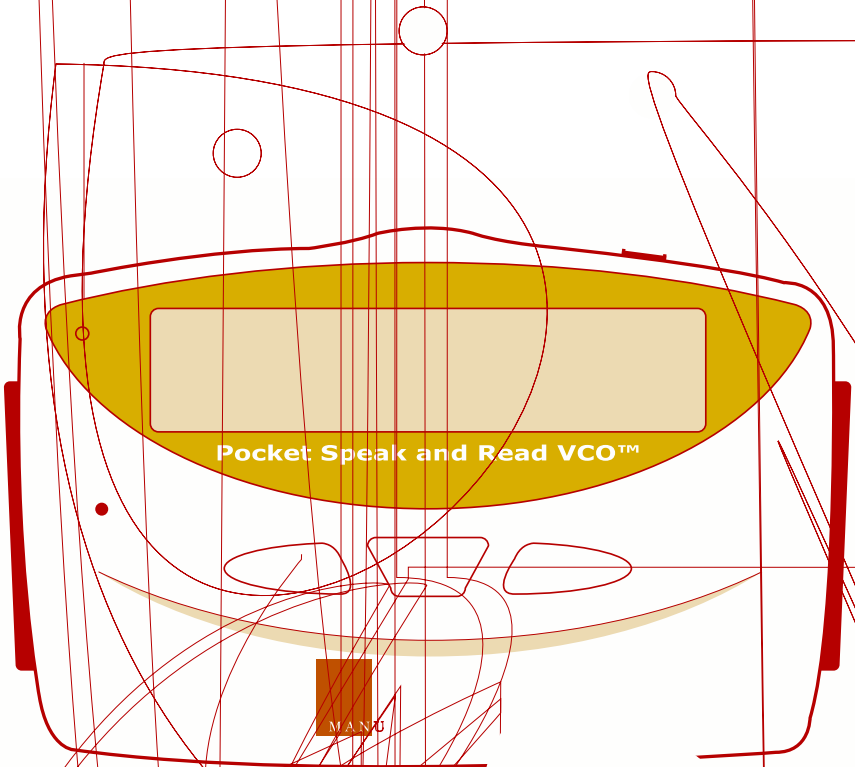

Pocket Speak and Read VCO™



# I

## INSTALLING BATTERY

The Pocket Speak and Read VCO® (PVCO) is powered by two AAA alkaline batteries. Install new batteries before you first use the PVCO. When the batteries begin to weaken, the PVCO will flash, “!!BATTERY LOW!!” four times when the PVCO is first turned on. At this time, it is best to replace the batteries immediately to ensure good working condition for the PVCO.

To install the battery please follow these easy steps.

1. Press ON/OFF button to turn off the unit.
2. Open the battery compartment cover by pushing in the direction of the arrow shown in the figure below.

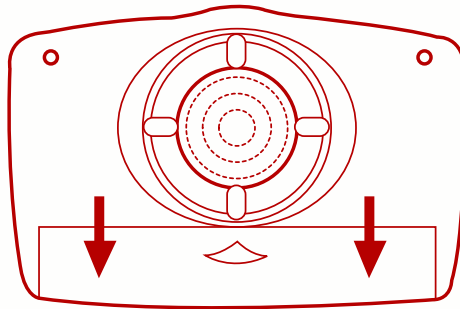

3. Remove old batteries, if necessary, and install new batteries as indicated by the polarity symbols (“+” and “-”) in the battery compartment.

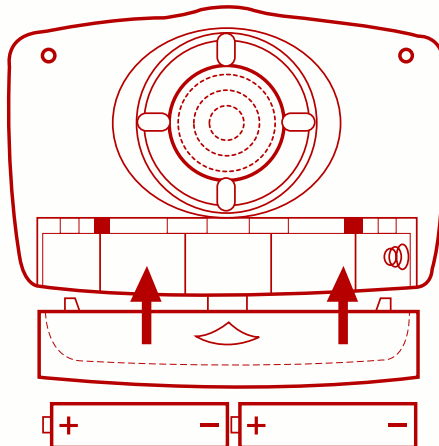

4. Replace the cover.

## II OPERATIONS

Pocket Speak and Read VCO® is very friendly to use. After installing the batteries, turn on the PVCO power by pressing the ON/OFF button (the center button). You should see the sign-on message, “Krown Manufacturing” on the display. The PVCO now is ready to use.

To make a telephone call, contact your state Relay service to set up the call for you. At the end of this manual you will find the list of Relay services for all of the United States. The Relay listing will be invaluable to you when communicating in your personal and professional life.

### 1. DIALING RELAY SERVICES

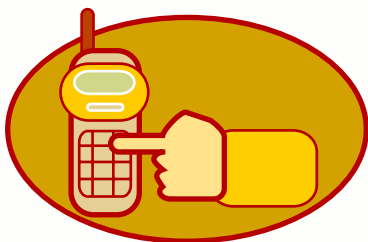

Pickup the handset of the telephone you are going to use. Put the PVCO firmly on the earpiece and watch the signal light (LED) on the left hand side of the display. The LED will light up when the telephone is ready to use. This light means that the PVCO is receiving a dial tone and is ready for you to make a phone call. If the LED

does not light up you may want to try again. If the second try results in the LED not lighting up, you may want to ask for assistance to see if there is another procedure required to make an outgoing call. Using the PVCO to make an outgoing call dial the Relay number on the phone keypad. Watch the LED for the progress of the call. If you see the LED turn on and off in 2 second cycle ON and 4 second cycle OFF, this indicates the ring feedback from the line. If the LED is flashing in half-second cycles, the line may be busy. You may want to hang up and try again.

If the LED is flickering, someone may be attempting to talk to you by voice. In this case, you need to explain your situation by using your voice. Speak directly to the caller and request they call Relay. When you dial Relay, the operator will identify themselves to you. Now it is time to send your VCO request to Relay Operator.

**What is PVCO?** VCO means “Voice Carry Over.” The pocket speak and read is specially designed for the deaf and hard of hearing who has a good speech ability and want to use their voice when making a relay call. How does relay work? Dial your state relay number (if there is a number for the VCO caller, use this number [see page 13 for list of relay service]). Tell the agent the phone number you want to call. The agent will notify you when the hearing person answers. Go ahead and speak to the mouthpiece. The hearing person will hear you voice directly. When they respond to you, the agent will type what they say to you. The relay service is free of charge and 100% confidential. If you have any difficulty understanding a conversation for various reasons, you can request translation during the call. ]

### 2. REQUESTING A VCO CALL



Move the PVCO down to the mouthpiece of the handset. Press the “VOICE” button. The machine is now sending a message to the Relay operator to make a VCO call. At the same time the machine will tell you to wait with the message “SENDING PLS WAIT.” After 2 seconds, the display will tell you “MOVE TO EARPIECE NOW.”

Please move the PVCO to the earpiece of the handset and tighten the elastic strap to the back of the unit around the handset. At this time, the Relay operator will request you to use voice to communicate with him or her by message (TALK NOW) or (VOICE NOW). The VCO call has now started.

### 3. VCO CONVERSATION

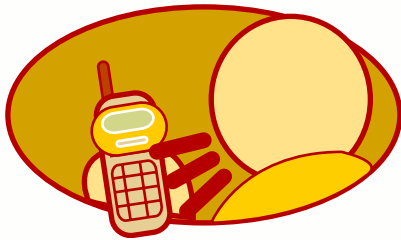

Speak the number you want to call directly into the mouthpiece of the handset. Say “GA” or “Go Ahead” after finishing the sentence. The LED lights up either when it is receiving from the operator or when you are speaking to the microphone. The progress of the call will show on screen from the Relay operator.

Now you can really enjoy the convenience of this PVCO. Simply speak to the phone and read the other person’s message back from the display.

### 4. END THE VCO CALL

To end the VCO conversation, you say “SK” or “Stop Keying”. Turn off the PVCO by pressing the POWER button again and hang up the phone.

### 5. USING PVCO IN THE DARK

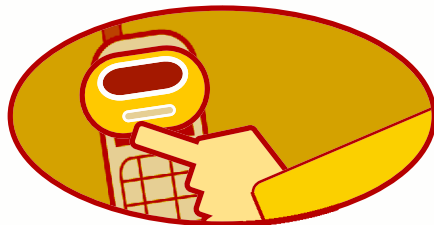

When you use the PVCO in the dark you can turn on the blue-green backlight to illuminate the screen. The button has the light bulb icon and is located on the left-hand side of the PVCO.

### 6. TAKING PVCO WITH YOU WHEN YOU TRAVEL

Prior to a trip, verify that the machine is ready. Turn on the unit. You should see the sign-on message. If not, install new batteries. Always carry extra batteries in the pouch for easy replacement. Discard the old ones, do not put them back into the pouch. It is a good idea to record every phone number into the phone book which is included in the PVCO owner’s manual.

### 7. IN CASE OF EMERGENCY

Dial 911 on the phone pad and wait until the operator answers. All 911 centers are answered by a staff person who determines if the call is a voice or TTY call. Move the unit down to the mouthpiece and press voice button. Wait until you see the message indicating it is finished, then move it back to the earpiece. Now you can talk to the Emergency operator and you can read the message from 911 on the display.

Note: Krown Manufacturing makes no representations that the 911 service will properly respond to a TDD/TTY call.

### 8. USING THE PVCO WITHOUT RELAY ASSISTANCE

If you know the hearing person has a TTY acoustic coupling with a telephone you can dial them direct without calling Relay service. Explain to the hearing person how PVCO works. The hearing person will listen to your voice and type back the answer by using their TTY/TDD. The PVCO user should wait approximately 3 seconds after seeing “GA” to speak. This time allows the person using the TTY the opportunity to pick up from and connect to the TTY without missing any of the conversation. It also ensures the conversation between you and the caller is strictly private.

### 9. USING THE PVCO WITH A CELL PHONE

The PVCO-C is modified to work with select digital cellular phones or cordless phones with a headset output. Consult your cellular phone manual for how to set up TTY/TDD mode. Set your cell phone to work with TTY compatible mode. Plug the communication cable to the cellphone and the PVCO-C.

First turn on the power for the PVCO-C and the mobile phone. Second, dial a TTY number or your State Relay Service on the mobile phone keypad. Watch the LED on the PVCO-C for calling progress. If you did not see any action for 15 seconds, hang up and redial that number. Third, waiting for the other party to answer your and end by a “GA”. It’s your turn to speak. Hold the PVCO-C close to you and speak clearly. Always end by saying GA or go ahead. Continue the conversation until both parties are ready to hang up. Hang up the mobile phone and turn off the PVCO-C.

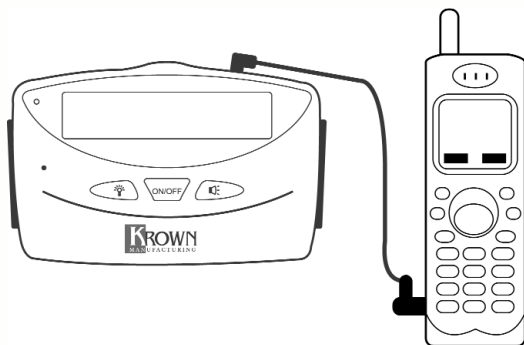



## II. Operation (CONT)

---

Charge your mobile phone every night to a full charge to make sure it ready to use next day. Use only the supplied cable to connect the PVCO-C to the mobile phone.

NOTE: When purchase the cell phone and sevice for your PVCO-C. Make sure your get a TTY compatible unit or look for a TTY-cellular telephone symbol.

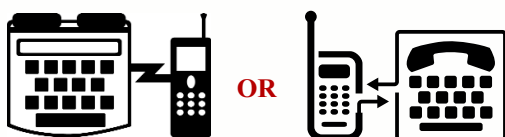

NOTE: Look for the logo on the cell phone box or brochure for a TTY/TDD Compatible. Always ask for a cell phone with vibrating mode in order to save you to buy a vibrating battery to use.

### **10. Answering an incoming mobile call**

Make sure to turn on the ringer of your mobile phone to be “ON” and in vibrating mode. If your battery does not support this mode you may need to order a vibrating battery from your mobile phone provider.

Connect the communication cable firmly on both mobile phone and PVCO-C. Answer the call on the cell phone by pressing talk or send button. (Refer to owner manual for more detail.) Say your greeting message and end by a “GA” or “Go ahead”. The conversation has begun. When you are ready to hang up, turn off your PVCO-C and hang up the cell phone.

NOTE: your cordless phone does not support vibrating ringer mode. Buy a tactile telephone signaler pager and install the transmitter into the telephone outlet. Wear the receiver on your belt.

- Keep the PVCO dry. If it gets wet, wipe it dry immediately. Liquids might contain minerals that can corrode the internal electronic components.
- Use and store the PVCO only in normal temperature environments. Extreme temperatures can shorten the life of electronic components, damage batteries, distort and possibly melt plastic parts.
- Handle the PVCO with care. Dropping it can cause internal working parts to fail or break the outer housing.
- Keep the PVCO away from dust and dirt, which can cause premature wear of parts.
- Clean the PVCO by wiping the unit with a damp cloth to keep it looking new. Do not use harsh chemicals, cleaning solvents, or strong detergents to clean the PVCO.
- When replacing the batteries, use only alkaline AAA batteries. Always remove old or weak batteries. Batteries can leak chemicals that can harm or destroy internal electronic components.

### **Frequently Asked Questions about using a PVCO**

Q: Can I call without using the state relay service?

A: Yes, you can call a hearing person directly if he or she has a TTY device. Please refer to your user manual for the procedure.

Q: Do I need to recharge it?

A: No, there is no need to recharge the batteries. The PVCO operates on two Alkaline AAA batteries. An extra set of batteries is included in the package. You can carry the batteries in its carrying pouch, which features a belt loop, two pockets to store two back-up batteries, and the user manual.

Q: What if the area is dark where I want to make a call?

A: There is a button on the PVCO for a backlight on the LCD screen. Please refer to your user manual for guidance.

Q: How will I know if my phone is ringing or if there is a busy signal?

A: A light signal indicator located in the upper left-hand corner of the LCD screen will help you to watch progress of your call. If it is blinking fast, you may have a busy signal.

Q: Why my LED turns on constantly?

A: If you use the PVCO with a cellphone or a cordless phone and get a LED on constantly, you may have feedback from the antenna. Turn off and turn it PVCO on to attenuate the EMI noise on the unit. If your LED is on by itself, you may need to a contact technical support person.

### III. Maintenance (CONT.)

---

Q: Will it work with only certain types of cell phones?

A: The PVCO-C is modified to work with the TTY compatible digital cell phone always looking for these icons before making a purchase for your cell phone.

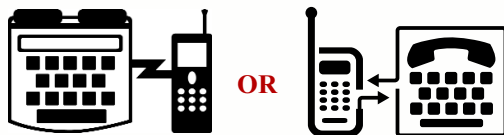

Q: If I am going overseas to another country can I still use my PVCO?

A: Some cell phones do not work overseas. Please contact your cell phone provider about any questions that you may have regarding this subject. If you plan to stay overseas and want to use PVCO to call home, you may need to purchase a temporary local cellphone to use with your PVCO.

**WARNING:** Modifying or tampering with the PVCO's internal components can cause a malfunction and might void its warranty. If your PVCO is not performing correctly, contact the manufacturer for assistance.

Power Requirements .....	2 AAA Alkaline Batteries
Baud Rate .....	45.5 Baud and/or 50.0 Baud
Telephone Connection Type.....	Acoustic
Dimensions .....	109 x 71 x 30mm
Weight.....	104g (including batteries)

### **FCC REQUIREMENT**

- This device complies with FCC Part 15, Subpart B, and IC regulation ICES-003
- EMC certificate was granted by WO#99108481
- Under the environment with radio frequency interference, the machine may malfunction and require the user to reset the PVCO.

Nationwide number for making VCO calls: 711. If it is not available in your area, please use the number in your area listed below.

### United States of America

Alabama	(800) 548-2546/T	Alaska	(800) 770-8973/T
Arizona	(800) 367-8939/T	Arkansas	(800) 285-1131/T
California	(800) 735-2929/T	Colorado	(800) 659-2656/T
Connecticut	(800) 842-9710/T	Delaware	(800) 232-5460/T
District of Columbia	(800) 855-1234/T	Florida	(800) 955-8771/T
Georgia	(800) 255-0056/T	Hawaii	(800) 643-8833/T
Idaho	(800) 377-3529/T	Illinois	(800) 526-0844/T
Indiana	(800) 743-3333/*	Iowa	(800) 735-2942/T
Kansas	(800) 766-3777/*	Kentucky	(800) 648-6056/T
Louisiana	(800) 846-5277/T	Maine	(800) 437-1220/T
Maryland	(800) 735-2258/*	Massachusetts	(800) 439-2370/T
Michigan	(800) 649-3777/*	Minnesota	(800) 627-3529/*
Mississippi	(800) 582-2233/*	Missouri	(800) 735-2966/T
Montana	(800) 253-4091/T	Nebraska	(800) 833-7352/T
Nevada	(800) 326-6868/T	New Hampshire	(800) 735-2964/*
	(800) 326-4013/V	New Jersey	(800) 852-7899/T
New Mexico	(800) 659-8331/T	New York	(800) 662-1220/T
North Carolina	(800) 735-2962/T	North Dakota	(800) 366-6888/T
Ohio	(800) 750-0750/*	Oklahoma (North)	(800) 722-0353/*
Oklahoma (South)	(800) 522-8506/*	Oregon	(800) 735-2900/*
Pennsylvania	(800) 654-5984/T	Puerto Rico	(800) 240-2050/T
Rhode Island	(800) 745-5555/*	South Carolina	(800) 735-2905/*
South Dakota	(800) 877-1113/*	Tennessee	(800) 848-0298/T
Texas	(877) 826-1789/V	Utah	(800) 346-4128/*
	(800) 735-2989/T	Salt Lake Area	(801) 298-9484/*
Vermont	(800) 253-0191/T	Virgin Islands	(800) 440-8477/T
Virginia	(800) 828-1120/T	Washington	(800) 833-6388/T
West Virginia	(800) 982-8771/T	Wisconsin	(800) 947-3529/*
Wyoming	(800) 877-9965/T		

### Canada

Alberta		British Columbia	
Manitoba	(800) 267-6511/T	Ontario	
Quebec		Saskatchewan	
New Brunswick		New Foundland	
Nova Scotia		Prince Edward Island	

\* = Voice, TTY, VCO  
 T = TTY/TDD  
 V = VCO

## VII WARRANTY

Krown Manufacturing warrants that the PVCO2000 or PVCO-C sold by Krown Manufacturing is free from defects in materials and workmanship under normal use and service for one year. This warranty is applicable only to the original purchaser of the PVCO2000 or PVCO-C when accompanied by a sales receipt stating the date of purchase and the name of company from which purchased. This warranty is in lieu and excludes all other warranties, expressed or implied, including any implied warranty of merchantability or fitness and of any obligation on the part of Krown Manufacturing. If the PVCO2000 or PVCO-C shall prove to be defective, then Krown Manufacturing shall either replace or repair the PVCO2000 at no cost to the original purchaser. Within one year period, the user may return the PVCO2000 to Krown Manufacturing at the following address:

Krown Manufacturing Inc.  
3408 Indale Road  
Fort Worth, Texas 76116

Shipping charges are at the customer's expense. Please include a check or money order made out to Krown Manufacturing in the amount of \$10 to cover shipping and handling. This warranty does not extend to any PVCO2000 sold by Krown Manufacturing which has been subjected to misuse, neglect, accident, improper application, improper installation or to use in violation of the instruction furnished by Krown Manufacturing. This warranty does not extend to or apply to any PVCO2000 which has been repaired or altered by any persons who have not been expressly approved by Krown Manufacturing.

Krown Manufacturing shall not be liable for any special consequential damages, for loss or expense directly or indirectly arising from use of the product, any inability to use them either separately or in combination with other equipment, product accessories or from any other cause. This warranty is only applicable to a product purchased through Krown Manufacturing, CompuTTY, or a Krown dealer. Other than as stated herein, there are no other warranties whether by the sample or model, by description or quantity, whether expressed or implied, and there are no implied warranties of fitness for a particular purpose or of merchantability.

**NOTE:** .....

.....

.....

.....

.....

.....

.....

.....

.....

.....

.....

.....

.....

.....

.....

.....

.....

.....

.....

.....

.....

.....

.....

.....

